

## Robinet latéral fermant à gauche froid - Chrome







CL.1

20 004 716

- diamètre de percement 32 mm
- rosace 60 x 47 mm
- avec marquage froid



S'adapte aux gammes suivantes : CL.1, CYO

|   |                             |               |
|---|-----------------------------|---------------|
|  | Chrome                      | 20 004 716-00 |
|  | Platine brossé              | 20 004 716-06 |
|  | Laiton brossé (Or 23cts)    | 20 004 716-28 |
|  | Champagne brossé (Or 22cts) | 20 004 716-46 |
|  | Champagne (Or 22cts)        | 20 004 716-47 |
|  | Dark Platinum brossé        | 20 004 716-99 |

20 004 716

mm [inches]



Diagramme de débit



Certificats

IAPMO\_4976 (5). IAPMO\_N-4976. LGA\_28687. IAPMO\_6397.

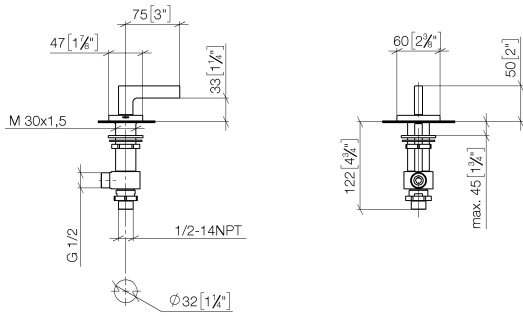
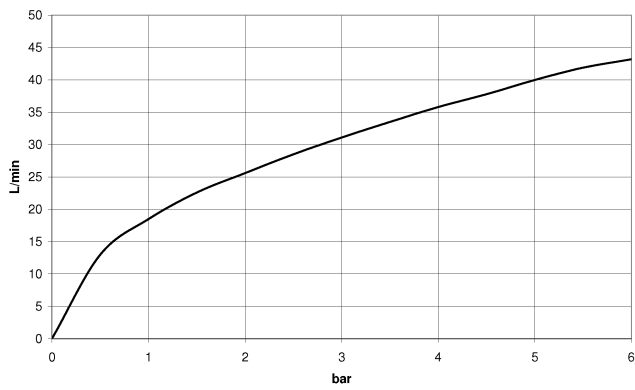